

# ACCESSORIES

## INSTITUTIONAL SHOWER HEADS

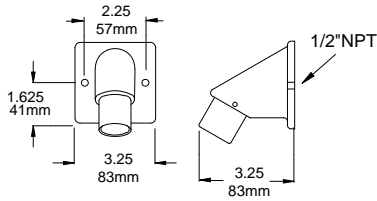

**H-06**

**H-06**

- Brass construction
- Vandal resistant screws
- 2.5 GPM (9.5 l/m) max. flow rate

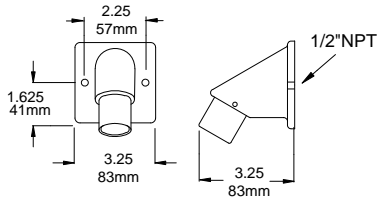

**H-06-1.5**

**H-06-1.5**

- Brass construction
- Vandal resistant screws
- 1.5 GPM (5.7 l/m) max. flow rate

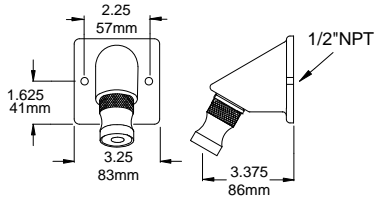

**H-06-ADJ**

**H-06-ADJ**

- Brass construction
- Adjustable spray (lockable)
- Vandal resistant screws
- 2.5 GPM (9.5 l/m) max. flow rate

**H-06/C102S**

- Brass construction head
- Brass ball joint and spray head
- Vandal resistant screws
- 2.0 GPM (7.7 l/m) max. flow rate

**H-07**

- Brass construction
- Ball joint
- Lever adjustable spray
- Vandal resistant screws
- 2.5 GPM (9.5 l/m) max. flow rate

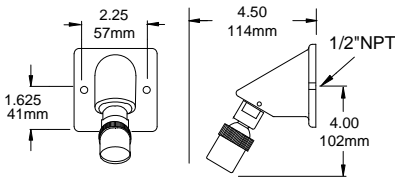

**H-06/C102S**

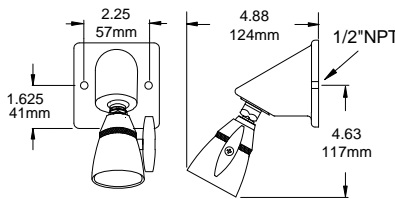

**H-07**

**H-08**

- Brass construction
- Ball joint
- Lever adjustable spray
- Vandal resistant screws
- 2.5 GPM (9.5 l/m) max. flow rate

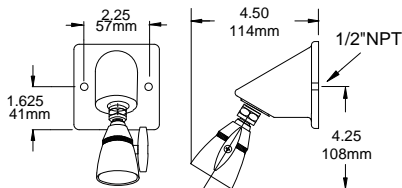

**H-08**

**OPTIONS:**

- \_\_SUFFIX AP - Anchor plate
- \_\_SUFFIX BP - Back plate
- \_\_SUFFIX V - Separate volume control



1360 Elmwood Avenue, Cranston, RI 02910 USA  
 Phone: 401.461.1200 Fax: 401.941.5310  
 Email: [info@leonardvalve.com](mailto:info@leonardvalve.com)  
 Web Site: <http://www.leonardvalve.com>

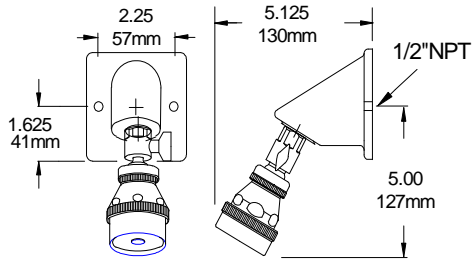

## H-10

- Brass construction
- Ball joint
- Vandal resistant screws
- 2.5 GPM (9.5 l/m) max. flow rate

## SUFFIX V - SEPARATE VOLUME CONTROL

A separate lever operated volume control is available on many institutional shower heads (see note below). It permits the user to shut down the flow of water while soaping.

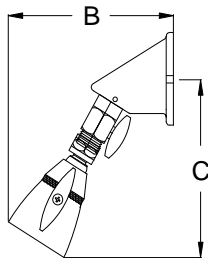

SHOWER HEAD	B	C
H-07	6"	5 5/8"
H-08	5 1/2"	5 1/4"
H-09	4 1/2"	4 1/4"

**NOTE:** Standard with model H-010, not available with model H-06. Separate volume controls are not recommended for use in areas where vandalism is high.

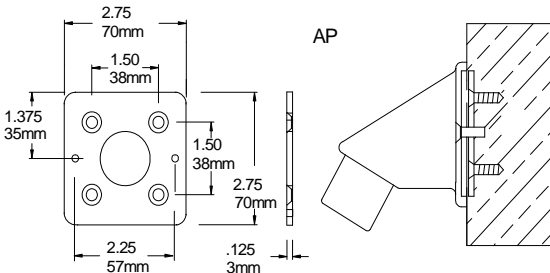

## SUFFIX AP - ANCHOR PLATE

Anchor plates provide additional mounting support and are tapped to accept the standard base mounting screws. Anchor plate mounting screws (1/4" screws with shields) are also furnished.

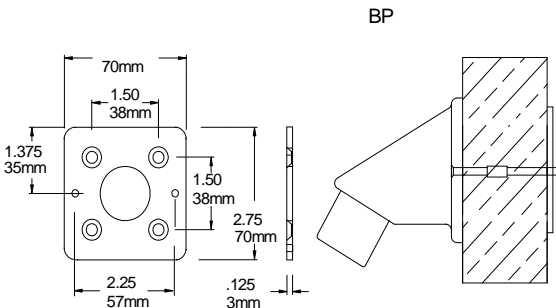

## SUFFIX BP - BACK PLATE

Back plates offer extremely secure mounting support from the rear of the wall and 3/16" screws with couplings and nuts (for up to 8" wall thickness) are provided



1360 Elmwood Avenue, Cranston, RI 02910 USA

Phone: 401.461.1200 Fax: 401.941.5310

Email: [info@leonardvalve.com](mailto:info@leonardvalve.com)

Web Site: <http://www.leonardvalve.com>